

MATING CONNECTOR (CA-01\_12MX150 ONLY)  
MOLEX 12-PIN MX150 KEYA  
CONNECTOR P/N: 33472-1201  
SOCKET P/N: 33012-2001  
CAVITY PLUG P/N: 34345-0001

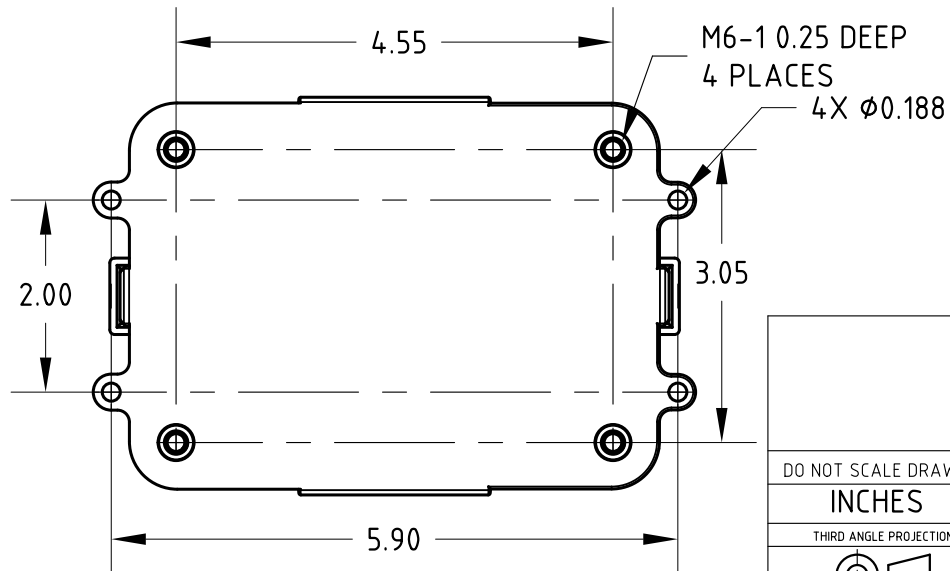
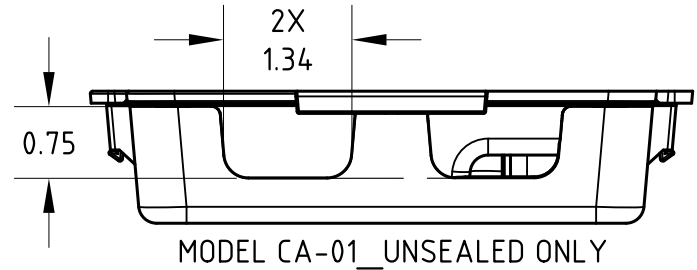

DO NOT SCALE DRAWING INCHES THIRD ANGLE PROJECTION	DRAWN	NAME	DATE	BACK 40 ENGINEERING	
	CHECKED	CNA	1/17/2016	WWW.BACK40ENG.COM	
	APPROVED			TITLE	
				CIRCUIT ARMOUR APPLICATION DATA	
	MATERIAL	FINISH	SIZE	DWG NO.	REV.
			A	CA-01_APPDATA	A
			SCALE	WEIGHT	SHEET
					1 OF 4

2

1

COVER OPTIONS  
SEE SHEET 1 FOR DIMENSIONS

UNSEALED COVER  
P/N - CA-01\_UNSEALED

BLANK SEALED COVER  
P/N - CA-01\_BLANK

SEALED CONNECTOR COVER  
P/N - CA-01\_12MX150

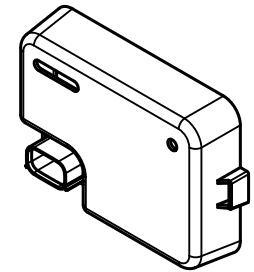
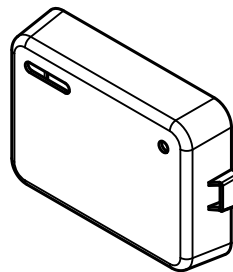
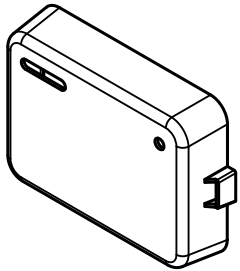
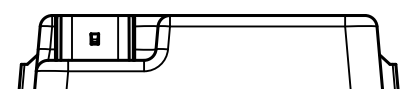
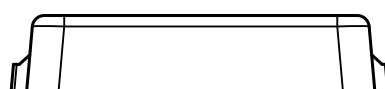
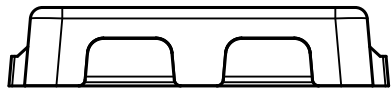
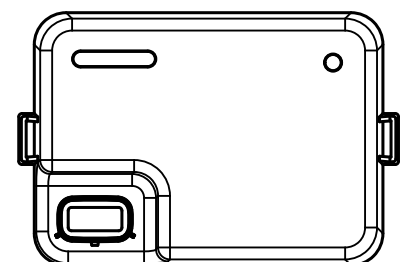
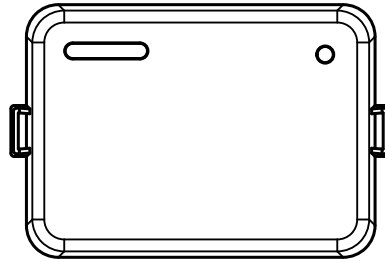
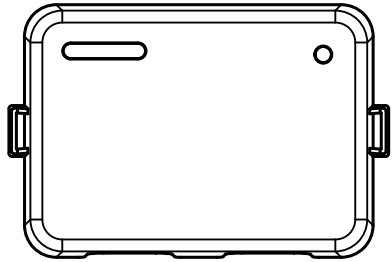
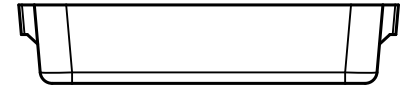
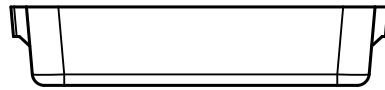
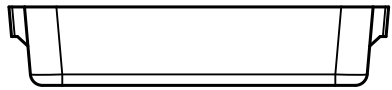

B

B

A

A

2

1

RECOMMENED BOARD SIZE/LAYOUT  
SEE SHEET 4 FOR PROTOBOARD LAYOUT

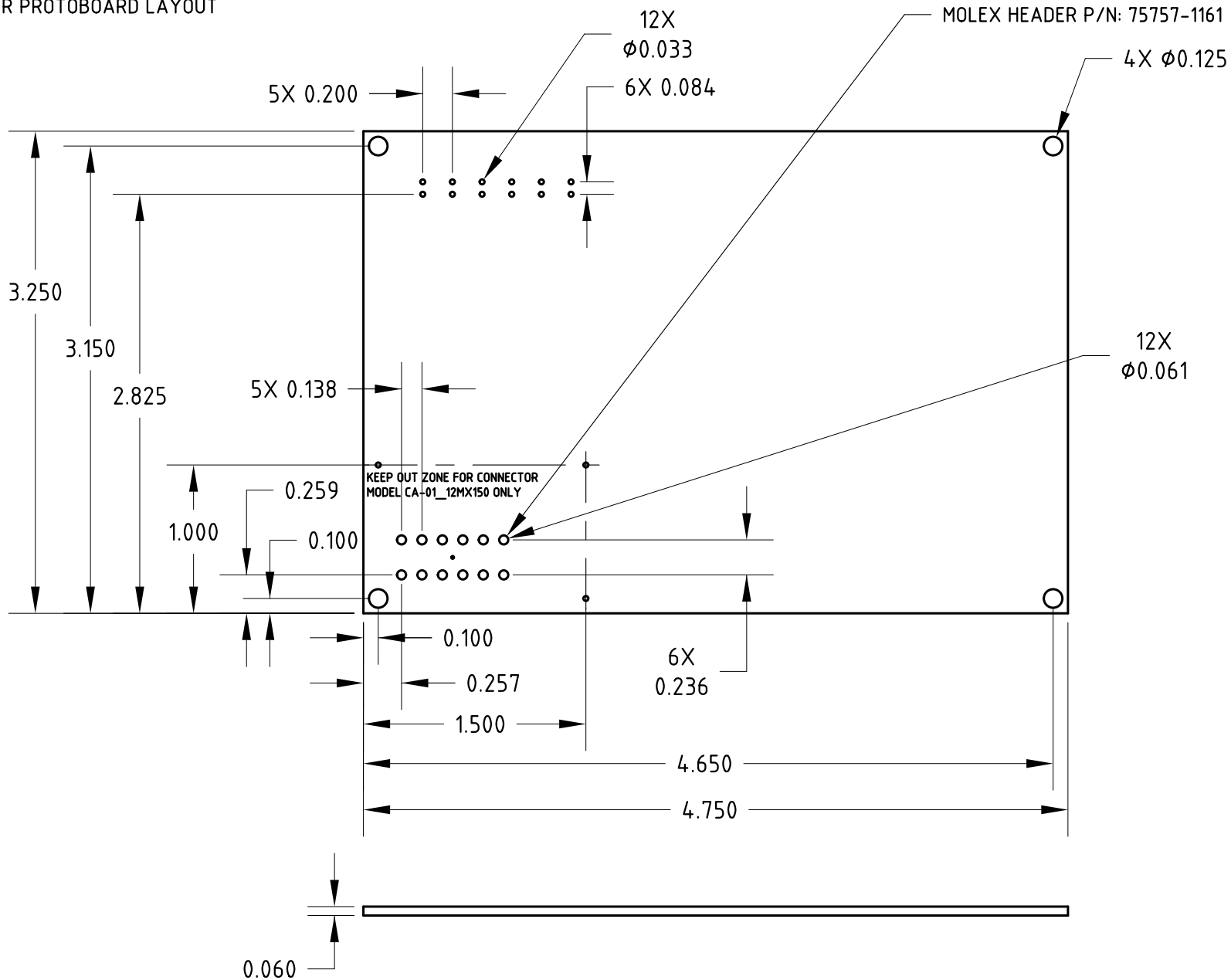

2

1

PROTOBOARD LAYOUT  
HOLE DIAMETER - 0.033  
HOLE SPACING - 0.1

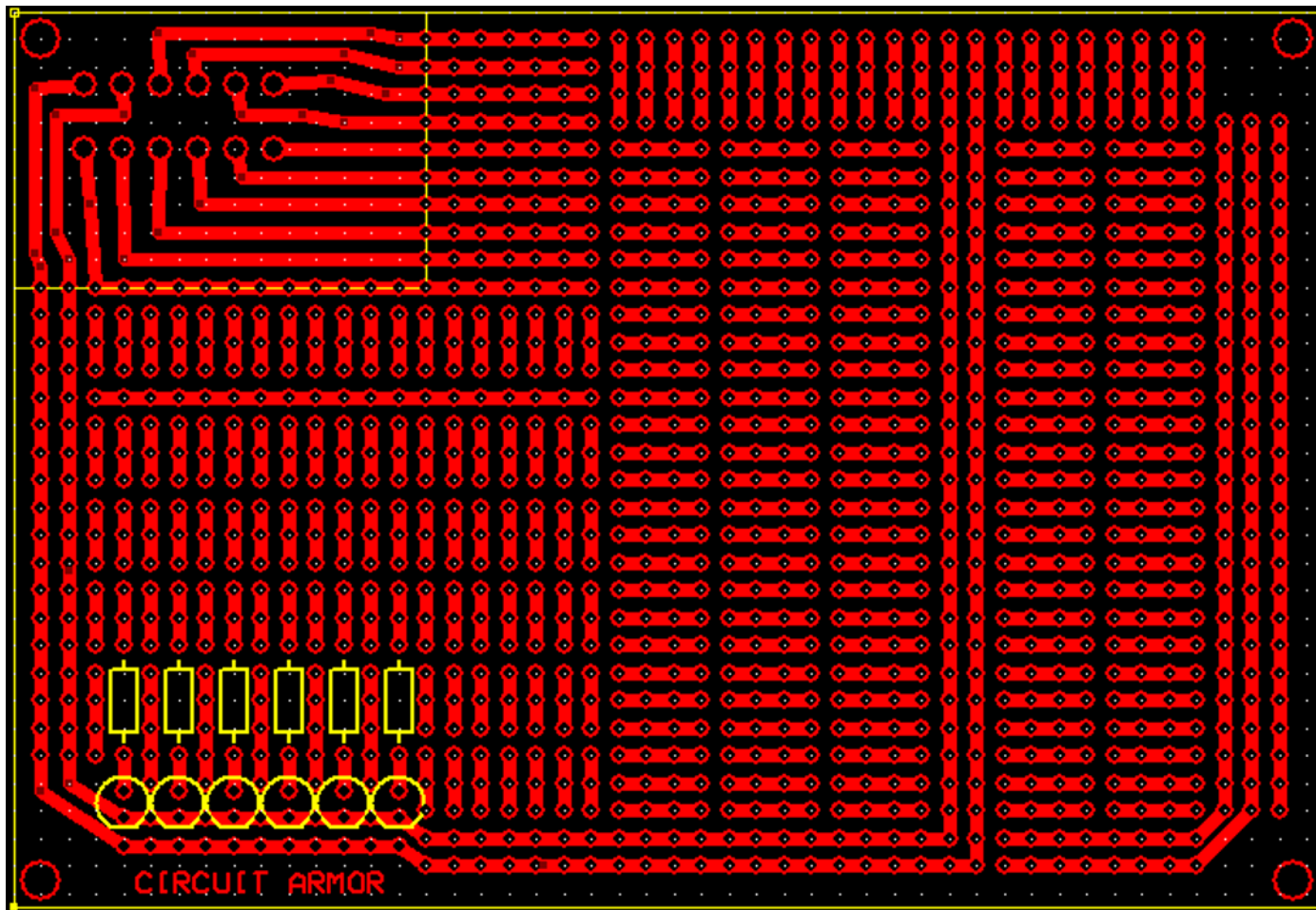

2

1

B

B

A

A